

1

2

3

4

5

6

A

A

B

B

C

C

D

D

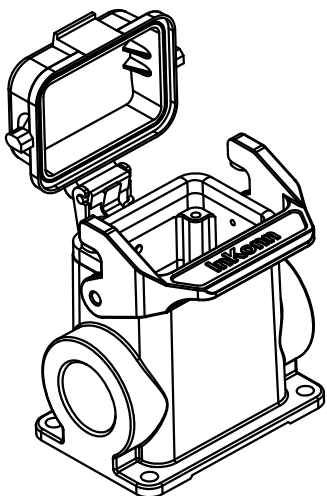
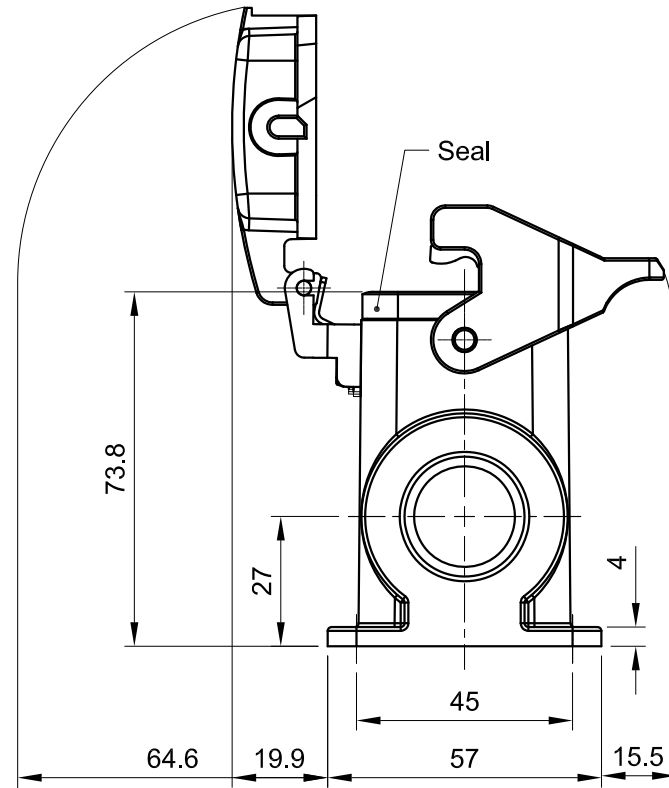
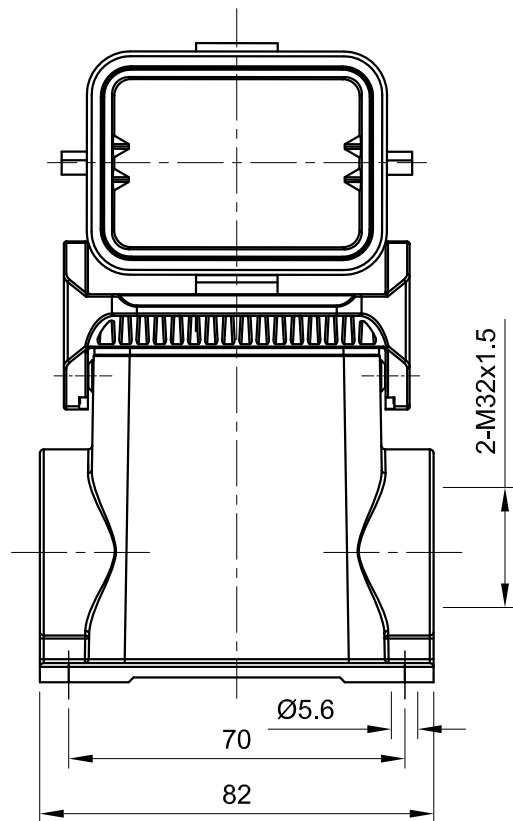

 InKonn (Suzhou) Electric Technology Co.,Ltd.	All Dimensions in mm Original Size DIN A4	Date 2019-12-1	Drawing No. TC1684573	Rev. A00	Scale 1:1.5
	Part No. 10 11 006 1653	Created by Shuxu Huang	Checked by Yiyi Luo	Page 1/1	Type Name HB6-HSM-PC-SL-2M32

1

2

3

4

5

6