

1 2 3 4 5 6

A

A

B

B



C

C

D

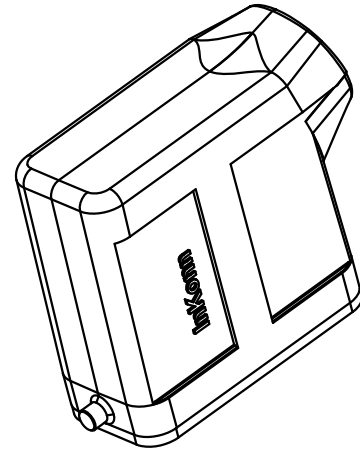
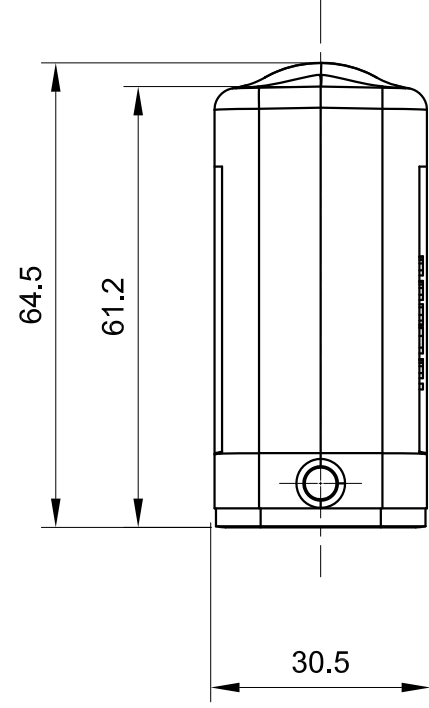
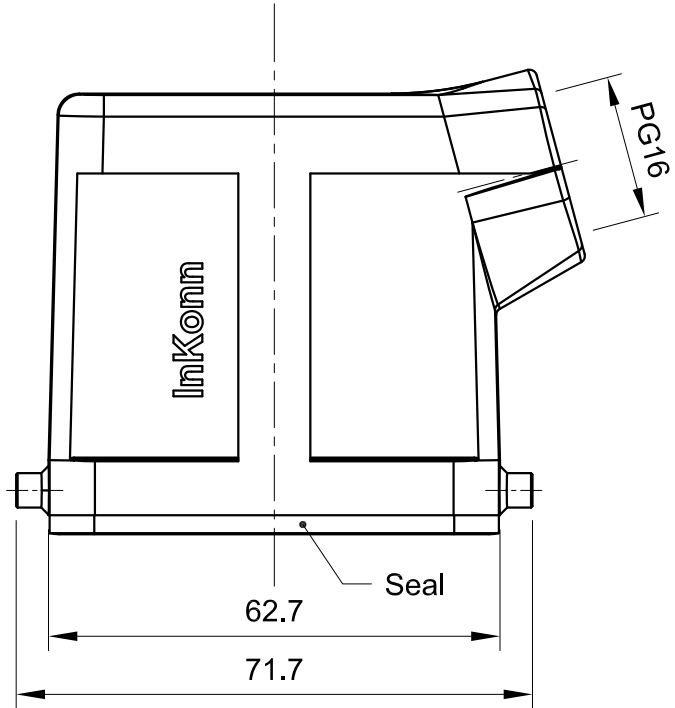
D



 InKonn (Suzhou) Electric Technology Co.,Ltd.	 All Dimensions in mm Original Size DIN A4	Date 2021-05-10	Drawing No. TC1807684	Rev. A00	Scale 1:1
	Type Name HA10-SE-DB-PG16	Part No. 10 01 810 0102	Created by Shuxu Huang	Checked by Yiyi Luo	Page 1/1

1 2 3 4 5 6